

B-ISSUE 01



DESIGN
BARAUSSE



Classico
BARAUSSE



Moderno
BARAUSSE

welcome to Barausse world



B LE PORTE DI
BARAUSSE ITALIAN
DESIGNER
DOORS

index

100% MADE IN ITALY	1
DESIGN BARAUSSE	2
CLASSICO BARAUSSE	4
MODERNO BARAUSSE	6
QUINTA	10
SECRET	13
HANDLES	14
BARAUSSE SUPPORT	15
BARAUSSE IN THE WORLD	16
IN THE NEXT ISSUE	17



pag. 14

Barausse recommends...

Selezione delle migliori maniglie per ottimi risultati funzionali ed estetici.

A selection of the best handles for excellent functional and aesthetic results.

Nabídka těch nejlepších klik a dveřního kování, které v sobě spojují vynikající funkční i estetické vlastnosti.

Выбор лучших ручек, гарантирующих превосходную функциональность и внешний вид.

Sélection des meilleurs poignées pour excellents résultats fonctionnels et esthétiques.

Wybór najlepszych klamek zapewniający optymalne rozwiązania pod kątem funkcjonalności i estetyki.



13CI05
September 2013

graphic design
Barausse S.p.A.

concept & copywriting
Barausse S.p.A.

photo
Vajenti, Photopiù,
Chilesotti

cover
Eleonora Musoni

printing
Compagnia
Nazionale Italiana

copyright
Barausse S.p.A.

All rights reserved.
Reproduction of any part of this document and publication on the Internet or on any other medium is not permitted without Barausse S.p.A. written permission.
The photographic reproduction of the colours, though very similar to reality, should be considered to be purely indicative.



100% MADE IN ITALY

Dal 1967 Barausse contribuisce ai valori del "Made in Italy". Tutte le nostre proposte sono creazioni originali. Il percorso produttivo, dalla progettazione alla realizzazione, avviene nello stabilimento di Monticello Conte Otto a Vicenza. Queste caratteristiche, che rendono Barausse unica, sono riassunte nel marchio "100% BARAUSSE MADE IN ITALY".

Od roku 1967 firma Barausse přispívá k hodnotám, označovaným "Made in Italy". Veškeré naše nabídky jsou originálními kreacemi. Výrobní proces, od provotního projektu až po realizaci se uskutečňuje ve výrobních halách ve městečku Monticello Conte Otto v okrese Vicenza. Tyto vlastnosti přispívají k faktu, že firma Barausse je tímto jedinečná a jsou ukázány ve značce "100 % BARAUSSE MADE IN ITALY".

Depuis 1967 Barausse contribue aux valeurs du "Made in Italy." Toutes nos propositions sont des créations originales. Le parcours productif, de la conception à la réalisation, se déroule à Monticello Conte Otto, Vicence. Ces caractéristiques, qui rendent Barausse unique, sont résumées dans la marque "100% BARAUSSE MADE IN ITALY".

Barausse has contributed to "Made in Italy" values since 1967. Every one of our proposals is an original creation. The entire manufacturing process, from design to realization, takes place at our facilities in Monticello Conte Otto, in Vicenza. These characteristics, that make Barausse unique, are summed up in the "100% BARAUSSE MADE IN ITALY" brand name.

С 1967 г. компания Barausse содействует ценностям под знаком «Сделано в Италии». Все наши предложения являются оригинальными изделиями. Производственный процесс, от стадии проектирования до изготовления, осуществляется на фабрике в Монтичелло-Конте-Отто провинции Виченцы. Эти характеристики, делающие компанию Barausse уникальной, резюмированы в знаке «100% BARAUSSE MADE IN ITALY».

Od roku 1967 firma Barausse wnosi swój wkład do wartości reprezentowanych przez znak "Made in Italy". Wszystkie nasze propozycje to wyroby oryginalne. Cały proces produkcyjny, od projektu po wykonanie, odbywa się w zakładzie w Monticello Conte Otto w Vicenza. Właśnie te cechy zostały zgrupowane pod znakiem "100% BARAUSSE MADE IN ITALY" i sprawiają, że Barausse to wyjątkowa firma.



Nazareno Barausse

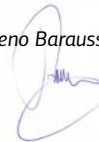

Welcome to Barausse world



prestige



safety



functionality

comfort



DESIGNER
Massimo Bellunato

DESIGN
BARAUSSE

BELLUNATO Collection

Real Wood®



1 Massimo Bellunato | 2, 3 BLANC
VALZER INNER2 | 4 BLANC
GEOMETRIA P | 5 BLANC DUNE



DESIGN
BARAUSSE

iosaghini collection

Real Wood®

DESIGNER
Massimo Iosa Ghini



1

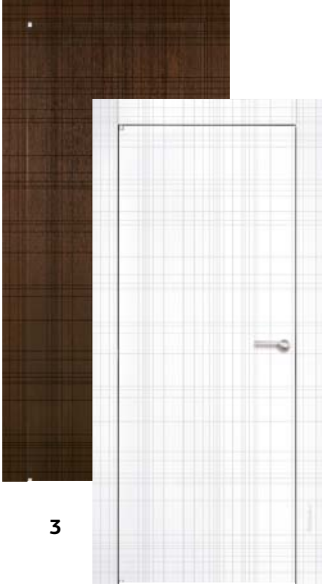

3



2



5



4

1 MIELE GRAFFIATA – SIA Guest / project Hall by Massimo Iosa Ghini | 2 MIELE GRAFFIATA INVERSO | 3 BLANC GRAFFIATA & CACAO GRAFFIATA | 4 BLANC FIORELLA O | 5 PIA B



1 1400 TIEPOLO 2BB / hand-painted artwork on board – model 2559 | 2 1300 TIZIANO 15BBR | 3 hand-painted artwork on board – model 2561 | 4 hand-painted artwork on board – model 2563 | 5 1600 BURANO 3P PLUS with golden molden | 6 1620 ANTICA VENEZIA 2G & 1620 ANTICA VENEZIA 8G

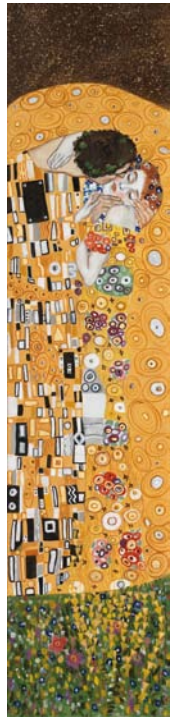

hand painted

Real Wood®

dipinto a mano
ručně malované
расписанный вручную
peint à la main
ręcznie malowane



3

4



6



5

LAB

Laboratorio Arte Barausse

Le elaborate porte di Barausse divengono pezzi unici quando abbinato al lavoro artistico e originale dei maestri della "Mariani Affreschi". È la fusione di arte e design che si realizza in ogni singolo pezzo. Unico e numerato.

The elaborate Barausse doors become unique pieces when combined with the artistic and original work by the "Mariani Affreschi" masters. It is a fusion of art and design that comes to fruition in each individual piece. Unique and numbered.

Díky umělecko-dekoračním zásahům týmu dílny "Mariani Affreschi" se dveře Barausse stávají skutečným uměleckým dílem. V této kolekci se snoubí umění s designem a každé dveře se tak stávají skutečným neopakovatelným originálem.

Искусные двери фабрики Бараусс обретают свою неповторимость в сочетании с художественными произведениями мастеров "Мариани Affreschi". И именно слияние искусства и дизайна воплощается в каждой двери, уникальной и неповторимой.

Les portes de Barausse deviennent pièces uniques lorsqu'ils sont combinées avec le travail artistique originale des maîtres de Mariani Affreschi. C'est la fusion de l'art et du design qui se réalise dans chaque pièce. Unique et numérotée.

Połączenie finezji drzwi Barausse z artystem i oryginalnością mistrzów firmy "Mariani Affreschi" przyczynia się do narodzin unikatowych egzemplarzy. Każdy z nich łączy w sobie sztukę i styl, jest niepowtarzalny i posiada swój numer.



2

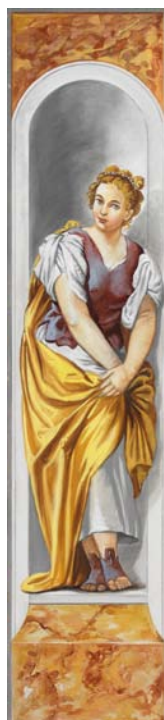

4



5



6



3

1 1600 DOGE PP LAB / hand-painted artwork on board – model 2562 | 2, 3 1750 DOGE 3P PLUS LAB with hand painted DA03 decoration / hand-painted artwork on board – model 2566 | 4 hand-painted artwork on board – model 2564 | 5 hand-painted artwork on board – model 2566 | 6 hand-painted artwork on board – model 2565



brushed

Real Wood®

spazzolato
kartáčovaný
бражированный
brossé
szczotkowany

1 ICE ON | 2
MIELE ON | 3
CACAO RIVER &
CACAO RIV-ON



VANILLA



BRANDY

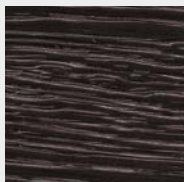

MASAI



ICE ONDA





1 BIANCO

shiny

lucido
leskly
глянцевый
brillant
błyszcząca

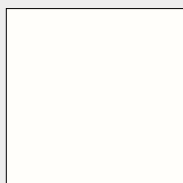

BIANCO

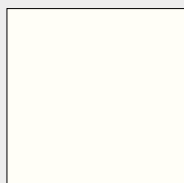

LATTE

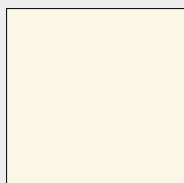

CREMA



TORTORA

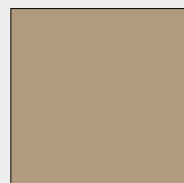

CAPPUCCINO

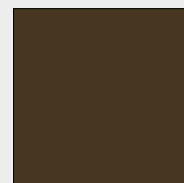

CAFFÈ

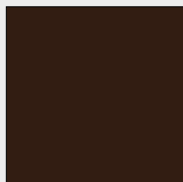

TERRA



SETA

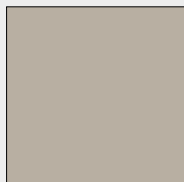

GRIGIO

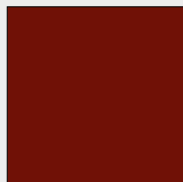

CHIANTI

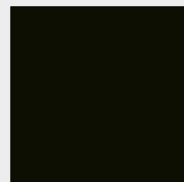

NERO

MODERNO BARAUSSE



veneered

Real Wood®

essenze
dýhy
материалы
essences
fornir

Moderno
BARAUSSE



1 CANALETTO ON RING | 2 GRALLEY ON INNER | 3 OLMO ON INNER2

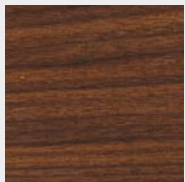

NOCE



WENGE

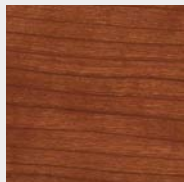

RUBER

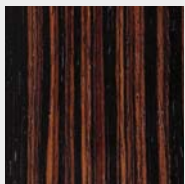

GIZA



SAHARA



coloured

Real Wood®

colorato
barevné provedení povrchu
покрашенные
coloré
kolorowy



1 BLANC INNER – custom model,
private residence, Italy | 2, 3 BLANC
TRATTO 10 – private residence, Italy

QUINTA

aluminium doors

porte in alluminio
hliníkové dveře
алюминиевые двери
portes en aluminium
drzwi w aluminium



VOLTA - FILO 41 ICE



1, 2 VOLTA – CENTRO 60 | 4,
5, 6 CENTRO 60 RING



ITALIAN DESIGNER DOORS



1 SECRET YOU with PUSH handle / GRIGIO SECRET with PUSH handle | 2, 3 PUSH handle



Rasomuro con telaio nascosto.
Tecnologia brevettata.

Flush sliding door with hidden frame.
Patented technology.

Zároveň se zdí a s neviditelnou zárubní.
Patentovaná technologie.

Невидимая дверь со скрытым коробом.
Запатентованная технология.

Aligné au mur, avec le cadre masqué.
Technologie brevetée.

Licowane z ukrytą ramą.
Opatentowana technologia.

secret[®]
chameleon door

HANDLES



Scarica la brochure "Maniglie"
Download the brochure "Handles"
Stáhněte si katalog "dveřních klik a kování"

Скачать брошюру "Ручки"
Télécharger la brochure "Poignées"
Pobierz katalog z klamkami

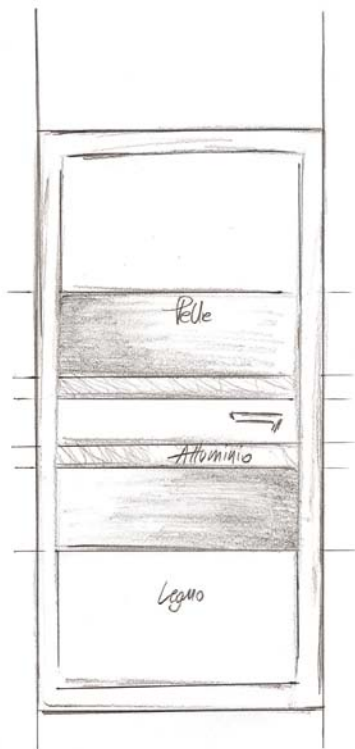

L'ufficio tecnico Barausse supporta la creatività di architetti e designers che intendano personalizzare gli ambienti senza rinunciare alle peculiarità estetico - funzionali dei nostri prodotti.

Technické oddělení společnosti Barausse podporuje kreativitu architektů a designérů, snažících se dodat interiéru osobitý, neopakovatelný charakter, bez opomenutí funkčních výhod a estetiky našich produktů.

Le bureau technique de Barausse encourage les architectes et les designers cherchant à personnaliser l'aménagement intérieur sans renoncer au caractère special esthetique et fonctionnel de nos produits.

Barausse's technical office supports the work of architects and designers who wish to personalize interiors without ignoring the special esthetical-functional characteristics of our products.

Технический отдел "Барауссе" поддерживает креативность архитекторов и дизайнеров, намеренных создавать помещения с учетом индивидуальных пожеланий клиентов, не отказываясь от функциональных особенностей и особенностей внешнего вида наших изделий.

Biuro techniczne Barausse wspiera architektów i projektantów pragnących nadać osobisty charakter wystrójowi wnętrz nie rezygnując jednocześnie z charakterystycznych dla naszych produktów cech estetyczno-funkcjonalnych.

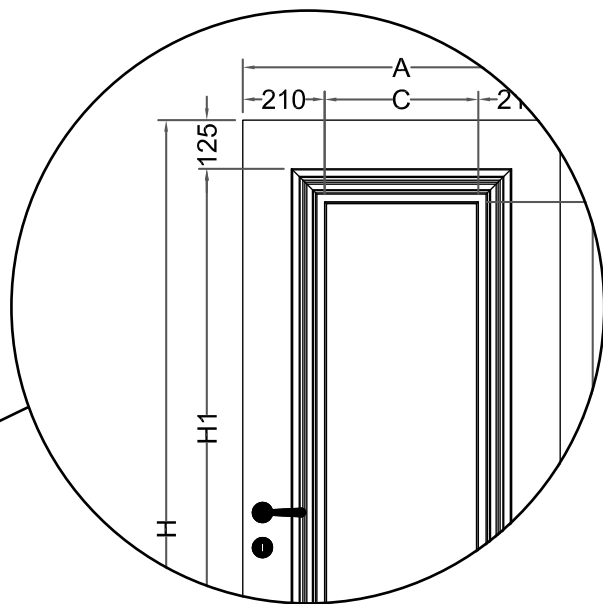
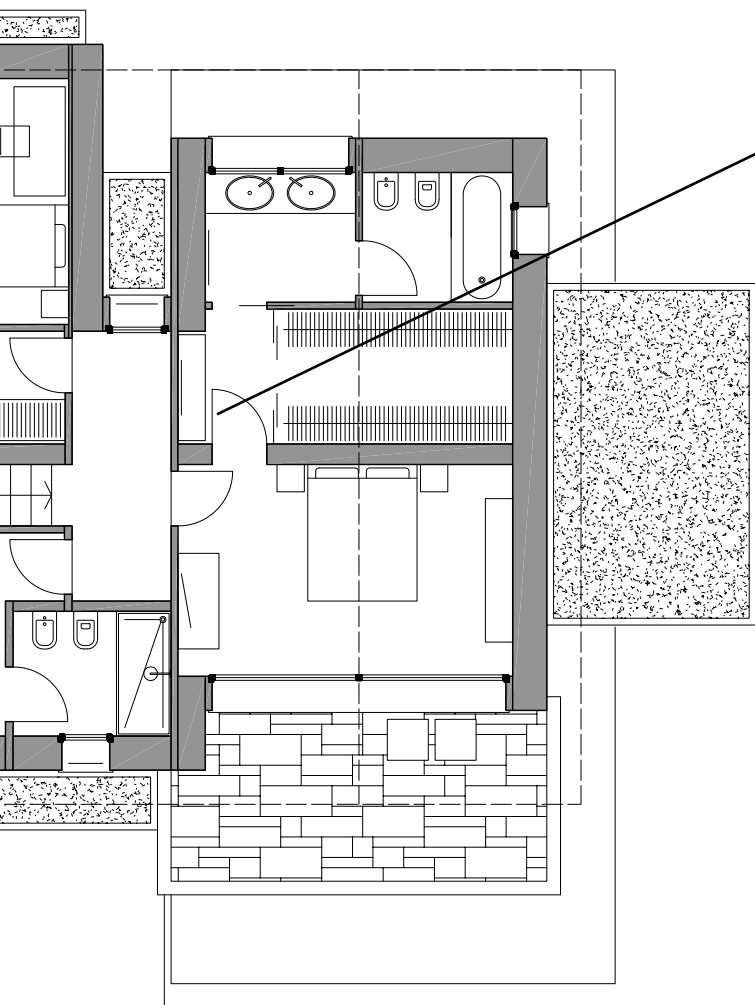

Barausse in the world



BARAUSSE

Manufacturing plant
via Parmesana, 27
36010 Monticello Conte Otto (VI) · Italy

BARAUSSE₀₀₀

Новоспаский пер. д.3 (ст. м. Таганская)
115172 Москва · Russian Federation

BARAUSSE POLSKA

Centrum Mega-Meble
Al. Jerozolimskie 200 · 02-486 Warszawa · Poland

BARAUSSE INDIA

9, Nungambakkam High Road, Nungambakkam
Chennai 600034, Tamil Nadu · India

CASAPALLADIO

2, Sun Flower Road – East Legon, Accra · Ghana

In the next issue...

Nel prossimo numero...
V příštím čísle se dočtete...
В следующем номере...
Dans le prochain numéro...
W następnym numerze...

boiserie

boiserie
boiserie
стеновые панели
boiserie
boazeria

F BOISERIE
BARAUSSE

mirrors

specchi
zrcadla
зеркала
miroirs
lustra

F RIFLESSI
BARAUSSE

flooring

pavimenti
podlahy
полы
parquet
podłogi

F PARQUET
BARAUSSE



www.barausse.com · info@barausse.com



lasagnini collection
PIA B

**DESIGN
BARAUSSE**

MADEexpo

Milan,
02_05 October 2013
Hall 5, Stand G25 H30



Krasnogorsk – Moscow,
Crocus Expo-2
16_19 October 2013
Hall 8, Stand D32 E35



Paris Nord Villepinte,
04_08 November 2013
Hall 6, Stand M30



Kiev,
19_22 February 2014



1600 BURANO 3P PLUS

Classico
BARAUSSE



SECRET YOU & GRIGIO SECRET · PUSH

**Moderno
BARAUSSE**



BARAUSSE S.p.A.

via Parmesana, 27
36010 Monticello Conte Otto (VI) Italy
tel. +39 0444 900 000
fax +39 0444 900 019
facebook.com/leportedibarusse
twitter @portedibarusse



www.barausse.com · info@barausse.com

CONTACT: Alexandru Scuturici
TEL:0721294477 web: www.usideinterior.net